

# SPECIFICATION FOR APPROVAL

CUSTOMER : \_\_\_\_\_

PRODUCT TYPE : SMD SEAM SEALING X'TAL 3.2×2.5

NOMINAL FREQ. : 37.400000MHz

TXC P/N : 7M37470001

REVISION : S1

CUSTOMER P/N : \_\_\_\_\_

PM / SALES : \_\_\_\_\_

DATE : \_\_\_\_\_

CUSTOMER SIGNATURE & Date \_\_\_\_\_

\_\_\_\_\_

- (1) TXC requires one copy returned with signature and title of authorized individual that signifies acceptance of the attached specifications.
- (2) Orders received and accepted by TXC after return of signed copy of specification will be produced per these specifications.
- (3) Any changes to these specifications must be agreed upon by both parties and new revision of the Product Specification Sheet will be issued.
- (4) Any issuance of purchase order prior to consigning back the Approval page of "Specification Sheets" from customers will be regarded as the agreement on the contents of these specifications.

Attachment: Product Specification Sheet

- 1
- 2
- 3
- 4
- 5

**RoHS Compliant**



**TXC CORPORATION**

4F, NO. 16, Sec. 2 Chung Yang S Rd., Peitou, Taipei, Taiwan.

TEL : 886-2-2894-1202 , 886-2-2895-2201 FAX : 886-2-2894-1206 , 886-2-2895-6207

www.txccorp.com

# PRODUCT SPECIFICATION SHEET

PRODUCT TYPE : SMD SEAM SEALING X'TAL 3.2×2.5

NOMINAL FREQ. : 37.400000MHz

TXC P/N : 7M37470001

REVISION : S1

PE/RD	QA	MFG
		
12-May-10		

**NOTE:**

- (1)Lead Free Products are "Directive 2002/95/EC of The European Parliament of 27 January 2003 on the restriction of the use of certain hazardous substances (RoHS) in electrical and electronic equipment" Compliant (Attachment: SGS Test Report).
- (2)Revision "Sx" is for engineering samples only. PE/RD's approval required.
- (3)Revision "Ax" is production ready. PE, QA and MFG's approval required

**RoHS Compliant**



## ELECTRICAL SPECIFICATIONS

### Standard atmospheric conditions

Unless otherwise specified, the standard range of atmospheric conditions for making measurement and tests are as follow:

Ambient temperature : 25±5  
 Relative humidity : 40%~70%

If there is any doubt about the results, measurement shall be made within the following limits:

Ambient temperature : 25±3  
 Relative humidity : 40%~70%

### Measure equipment

Electrical characteristics measured by HP E5100A or equivalent.

### Crystal cutting type

The crystal is using AT CUT (thickness shear mode).

### Unit Weight:

0.018±0.001 g/pcs

	Parameters	Symbol	Electrical Spec.				Notes
			Min.	Typ.	Max.	Units	
1	Nominal Frequency	FL	37.400000			MHz	-
2	Oscillation Mode	-	Fundamental			-	-
3	Load Capacitance	CL	18			pF	-
4	Frequency Tolerance	-	±10			ppm	at 25 ± 3
5	Frequency Stability	-	±10			ppm	Over Operating Temp. Range (Reference 25 )
6	Operating Temperature	-	-20	~	75		-
7	Aging	-	±3			ppm	1st Year
8	Drive Level	DL	-	-	200	uW	-
9	Equivalent Series Resistance	ESR	-	-	50	Ω	-
10	Shunt Capacitance C0	C0	-	-	5	pF	-
11	Insulation Resistance	-	500	-	-	MΩ	at DC 100V
12	Storage Temperature Range	-	-40	~	85		-

**DIMENSIONS**

(Unit:mm)

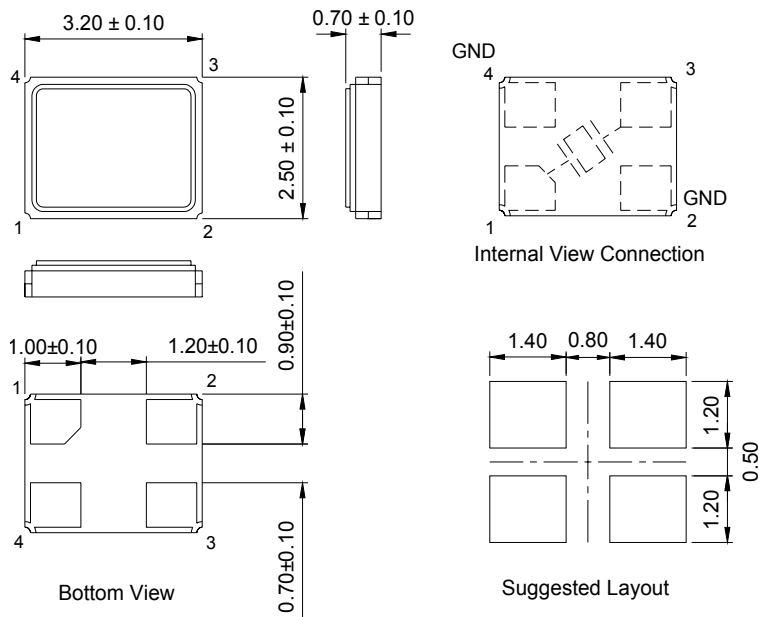

**MARKING**

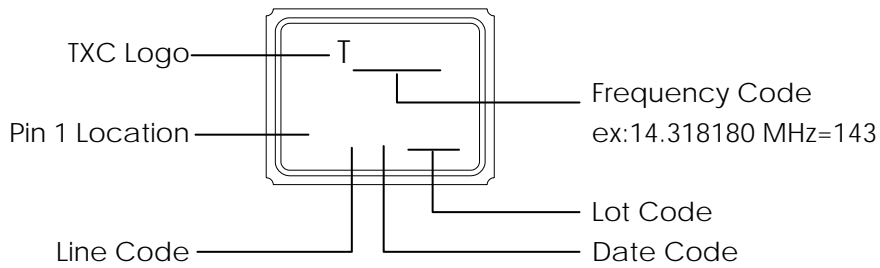

**Date Code:**

YEAR \ MONTH				JAN	FEB	MAR	APR	MAY	JUN	JUL	AUG	SEP	OCT	NOV	DEC
				A	B	C	D	E	F	G	H	J	K	L	M
2005	2009	2013	2017	N	P	Q	R	S	T	U	V	W	X	Y	Z
2006	2010	2014	2018	a	b	c	d	e	f	g	h	j	k	l	m
2007	2011	2015	2019	n	p	q	r	s	t	u	v	w	x	y	z
2008	2012	2016	2020												

\*This date code will be cycled every four years

**Production location: Taiwan**

**SUGGESTED REFLOW PROFILE**

Total time : 200 sec. Max.

Solder melting point :220

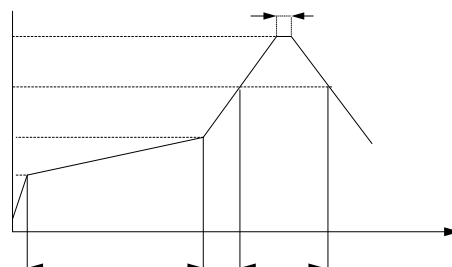

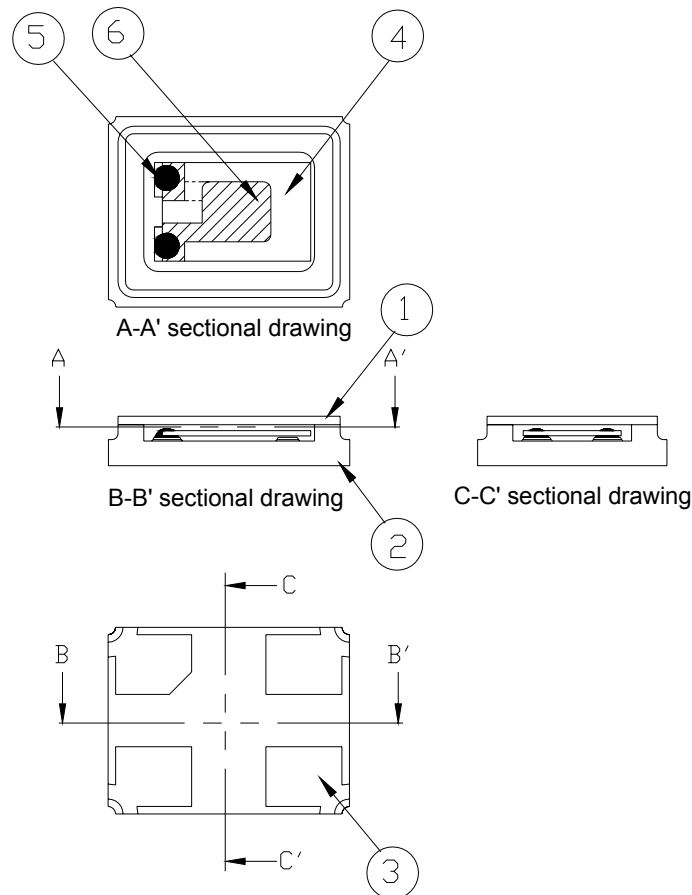
**STRUCTURE ILLUSTRATION**

NO	COMPONENTS	MATERIALS	FINISH/SPECIFICATIONS
1	Lid	Kovar (Fe/Co/Ni)	-
2	Base(Package)	Ceramic (Al <sub>2</sub> O <sub>3</sub> ) + Kovar (Fe/Co/Ni)+ Ag/Cu	Color black
3	PAD	Au	Tungsten metalize + Ni plating + Au plating
4	Crystal blank	SiO <sub>2</sub>	-
5	Conductive adhesive	Ag	Silicon resin
6	Electrode	Noble Metal	-

**PACKING**

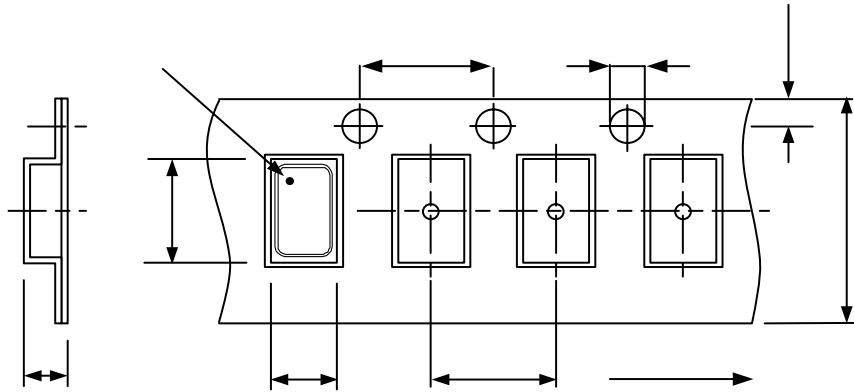

DIMENSIONS	A	B	C	D	E	F	<b>INDEX MARK</b>	
	1.65	3.4	2.7	4	8	4	1.55	1.75 (UNIT : mm)

F

REMARK :

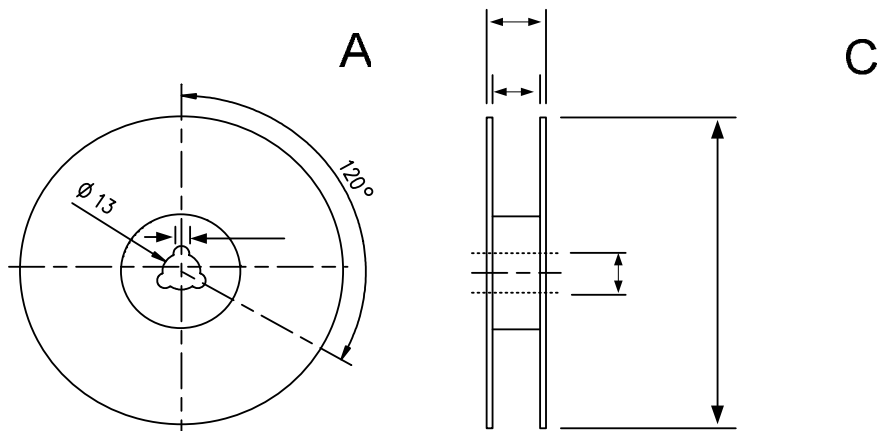
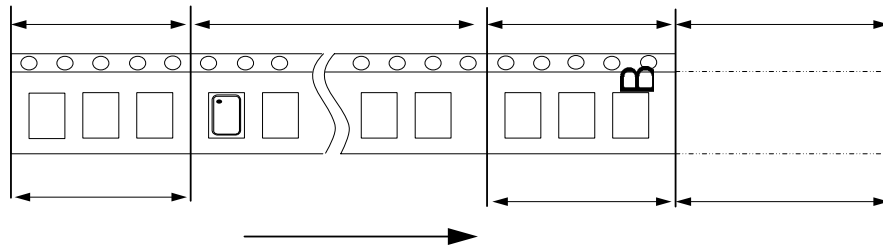

DIMENSIONS	L	L1	W	W1	pcs / Reel (UNIT : mm)
	178	13	11.5	8	Standard Reel Quantity is 3,000 pcs per reel

