

G.R.T Crystal HC 49/SMD 6.000MHZ



● Applications

Cordless Telephones • Facsimile • Copy Machine

● Features

- Dimensions (12.3×4.7×H)
- Metal Package
- Leadless Type • Resistance Sealed
- Tight Tolerance and Stability
- SMD Lower Height Design
- RoHS Compliant



▼ Specifications

Type	GRT49SMD6.000MF20E35	
Nominal frequency range	6.000MHz	
Crystal cut	Fundamental [AT-cut]	
Storage temperature range	-40 — 85°C	
Operating temperature range	-20 — 70°C	
Frequency temperature characteristics	± 20	
	± 30 -- ±50	
Equivalent series resistance	Please refer to the following ESR Table	
Load capacitance	Series 20pF	
Shunt capacitance	5pF max.	
Level of drive		

Package quantity : 1,000pcs max./reel.

▼ Outline Dimensions [unit:mm]

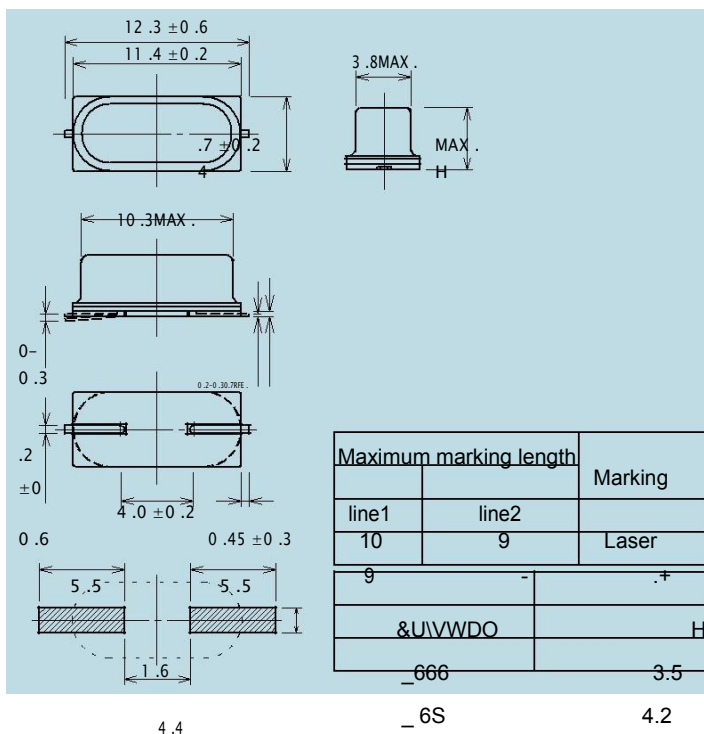

▼ ESR Table

Frequency [MHz]	
Fundamental	ESR [Ω]
3.500-3.999	150
4.000-4.999	120
5.000-5.999	100
6.000-8.999	80
9.000-9.999	60
10.000-12.999	50
13.000-18.999	40
19.000-40.000	30
3rd overtone	ESR [Ω]
30.000-44.999	80
45.000-59.999	70
60.000-80.000	60