

CRYSTAL SPECIFICATION



Customer : _____
Customer P/N : _____
Agent : _____
Agent Code : _____
SIWARD P/N : XTL501150-T296-078

Customer Approval :

希華晶體科技股份有限公司
SIWARD CRYSTAL TECHNOLOGY CO., LTD.

業務部/ SALE DEPARTMENT
TEL: (04)25347909
FAX: (04)25327885 / 25337396
URL HTTP://www.siward.com.tw

DATE : 2018/01/19

Approved By : *Steve Chen*

品質保證部/ QUALITY ASSURANCE DEPT.
TEL: (04)25347909 EXT 1340/1341

Checked By : *Tom Tang*

研發部/R & D DEPT.
TEL: (04)25347909 EXT 1521

Designer : *Sally Lin*

Address: 1-1, LANE 111, JUNG-SHAN RD., SEC.3, TANTZU HSING, TAICHUNG 427, TAIWAN, R.O.C.

Rev.	Description of Revision History	Date	Designer	Checked By
1	New Publication	2014/02/25	Sally Lin	Tom Tang

CRYSTAL SPECIFICATION

- 1. Description : Quartz Crystal
 - 2. Nominal Frequency : 20.000000 MHz
 - 3. Center Frequency : 20.000000 MHz
 - 4. Dimension & Drawing No. : SX-2016 ; SXD-00280
 - 5. Oscillation Mode : Fundamental
 - 6. Cutting Mode : AT cut
 - 7. Packing Style : TP-123
 - 8. Measurement Instrument : S&A 250B(Measured FL)
 - 9. Electrical Characteristics :
- [1] Operating Conditions :

Item	Symbol	MIN.	TYP.	MAX.	Unit	Condition
Operating Temperature Range	Topt	-40		85	°C	
Storage Temperature Range	Tstg	-40		90	°C	
Load Capacitance	CL		18		pF	
Drive Level	DL			100	μW	

[2] Frequency Stability :

Item	Symbol	MIN.	TYP.	MAX.	Unit	Condition
Tolerance	dF/Fo	-10		10	ppm	Refer to Center Frequency @25±3°C
Stability Over Temperature	dF/F25	-15		15	ppm	Refer to Operating Temperature
Aging	dF/F25	-2		2	ppm	Per Year

dF/Fo: Frequency Deviation Refer to Center Frequency

dF/F25: Frequency Deviation Refer to 25 °C Frequency

[3] Electrical Performance :

Item	Symbol	MIN.	TYP.	MAX.	Unit	Condition
Equivalent Series Resistance	ESR			100	Ω	@Series
Shunt Capacitance	C0			5	pF	
Insulation Resistance	IR	500			MΩ	@DC 100 Volt

10. Marking : Laser

<p>*MARKING : D ->YEAR C -> MONTH YEAR : 1 2 3 4 5 6 7 8 9 0 CODE : A B C D E F G H J K MONTH: 1 2 3 4 5 6 7 8 9 10 11 12 CODE : A B C D E F G H J K L M</p>	<div style="border: 1px solid black; padding: 10px; width: 80px; margin: auto;"> <p>20.0</p> <p>S DC</p> </div>
--	---

11. Remark :

<p>* The component complies with Moisture Sensitivity Level 1 defined on JEDEC J-STD-020 standard. * Compliant with RoHS and Siward QAD-S-116 Standard.</p>
--

■Note

1.General cleaning solutions or ultrasonic cleaning method may be used to clean our products. However, under certain circumstances, ultrasonic cleaning machine could generate resonance at the oscillation frequency of our products and thus deteriorate the electrical characteristics in devices, and even damage the overall structure of devices. Therefore, verification test is recommended before cleaning.

2.Avoid mounting and processing by Ultrasonic welding this method has a possibility of an excessive vibration spreading inside the crystal products and becoming the cause of characteristic deterioration and not oscillating.

■ DIMENSIONS

Unit: mm

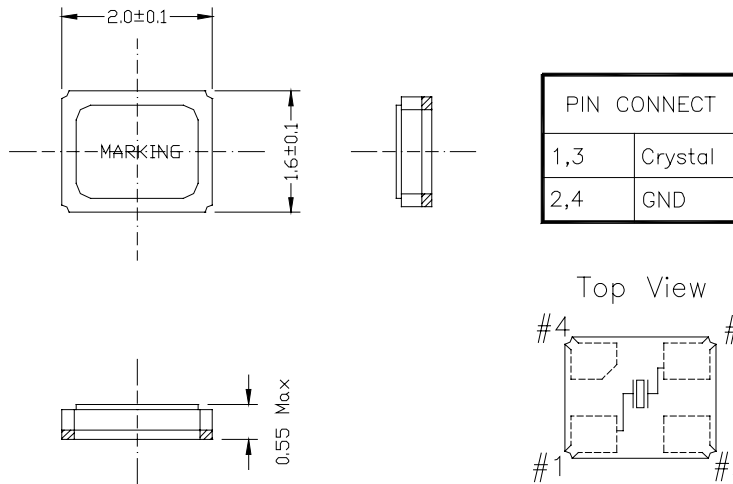

LAND PATTERN (REFERENCE)

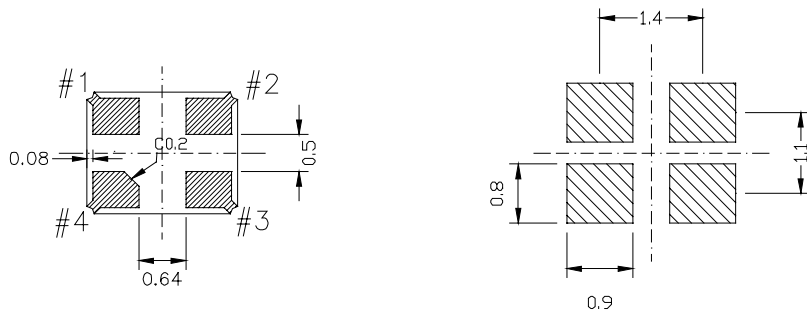

■ STRUCTURE ILLUSTRATION

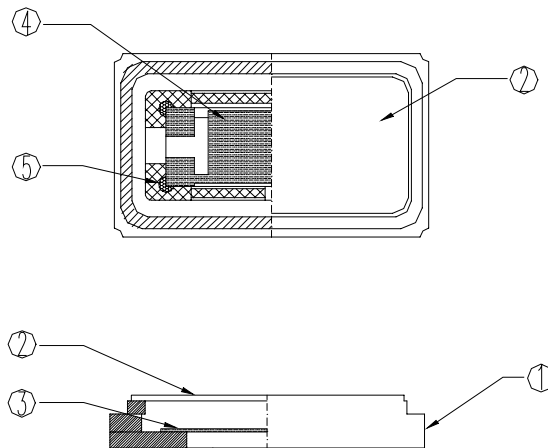

PART NAME		MATERIAL	PART NAME		MATERIAL
1.	BASE	CERAMIC	4.	ELECTRODE	Metal
2.	LID	KOVAR	5.	ADHESMES	SILVER GLUE
3.	BLANK	QUARTZ			

■ RELIABILITY SPECIFICATION

REFER TO JIS C 6701

1. ENVIRONMENTAL PERFORMANCE

ITEM	CONDITION										
1. HIGH TEMPERATURE STORAGE	STORED AT 85±2°C FOR 720±12H. (If Customer's temperature request is higher than the standard, Temperature test must be done for customer requirements.) THEN 25±2°C OVER 2H BEFORE TESTING.										
2. LOW TEMPERATURE STORAGE	STORED AT -40±2°C FOR 500±12H. (If Customer's temperature request is lower than the standard, Temperature test must be done for customer requirements.) THEN 25±2°C OVER 2H BEFORE TESTING.										
3. HIGH TEMP. & HUMIDITY	STORED AT 60±2°C AND HUMIDITY 90~95% FOR 500±12 H. THEN 25±2°C OVER 2H BEFORE TESTING.										
4. TEMPERATURE CYCLE	THE CRYSTAL UNIT SHALL BE SUBJECTED TO 100 SUCCESSIVE CHANGE OF TEMPERATURE CYCLES, THEN 25 ±2°C OVER 2 H BEFORE TESTING, EACH CYCLE AS BELLOW : <table border="0" style="margin-left: 40px;"> <thead> <tr> <th style="text-align: left;">TEMPERATURE</th> <th style="text-align: left;">DURATION</th> </tr> </thead> <tbody> <tr> <td>1. -40+0/-6°C</td> <td>30±3 MINUTES</td> </tr> <tr> <td>2. 25°C±2°C</td> <td>2~3 MINUTES</td> </tr> <tr> <td>3. 85+4/-0°C</td> <td>30 ±3 MINUTES</td> </tr> <tr> <td>4. 25°C±2°C</td> <td>2~3 MINUTES</td> </tr> </tbody> </table>	TEMPERATURE	DURATION	1. -40+0/-6°C	30±3 MINUTES	2. 25°C±2°C	2~3 MINUTES	3. 85+4/-0°C	30 ±3 MINUTES	4. 25°C±2°C	2~3 MINUTES
TEMPERATURE	DURATION										
1. -40+0/-6°C	30±3 MINUTES										
2. 25°C±2°C	2~3 MINUTES										
3. 85+4/-0°C	30 ±3 MINUTES										
4. 25°C±2°C	2~3 MINUTES										

2. MECHANICAL PERFORMANCE

ITEM	CONDITION
5. SOLDERABILITY	THE LEAD IS IMMersed IN A 260±5°C SOLDER BATH WITHIN 2±0.6 SECONDS.
6. RESISTANCE TO SOLDERING HEAT	REFLOW CHART AS ATTACH SHEET. TWICE PASS.
7. FREE FALL	FREE DROPPING FROM 75 cm HEIGHT 3 TIMES ON A HARD WOODEN BOARD.
8. VIBRATION	FREQUENCY : 10~55Hz, AMPLITUDE (TOTAL EXCURSION) : 1.5mm±15%, SWEEP TIME : 1MIN, 3 DIRECTION(X, Y, Z) EACH FOR 2 Hrs.
9. GROSS LEAK	STANDARD SAMPLE FOR AUTOMATIC GROSS LEAK DETECTOR, TEST PRESSURE: 0.2 Mpa
10. FINE LEAK	HELIUM BOMBING 5.0~5.5 Kgf / cm ² FOR 2 HOURS.

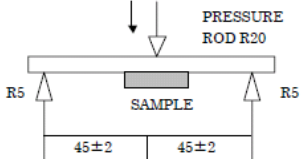
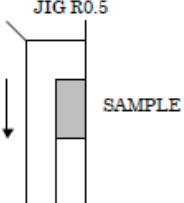
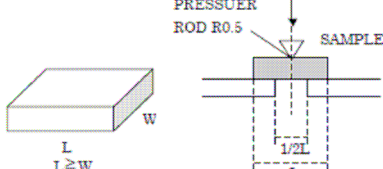
<p>11. TERMINAL STRENGTH</p>	<p>SHALL BE PRESSURIZED AT A SPEED OF APPROX.0.5mm/sec IN THE DIRECTION INDICATED BY THE ARROW UNTIL THE BENDING WIDTH REACHES 3mm AND HELD FOR 5 SECONDS.</p> 
<p>12. STICKING TENDENCY</p>	<p>A R0.5 JIG SHALL BE USED TO APPLY A 10N DEAD LOAD IN THE DIRECTION INDICATED BY THE ARROW TO THE ELEMENT AND RETAIN IT FOR 10 SECONDS.</p> 
<p>13. ELEMENT ASSEMBLY STRENGTH</p>	<p>A R0.5 PRESSURIZED BAR SHALL BE USED TO APPLY A 10N LOAD IN THE CENTER OF ELEMENT AND RETAIN IT FOR 10 SECONDS.</p> 

■ SUGGESTED REFLOW PROFILE

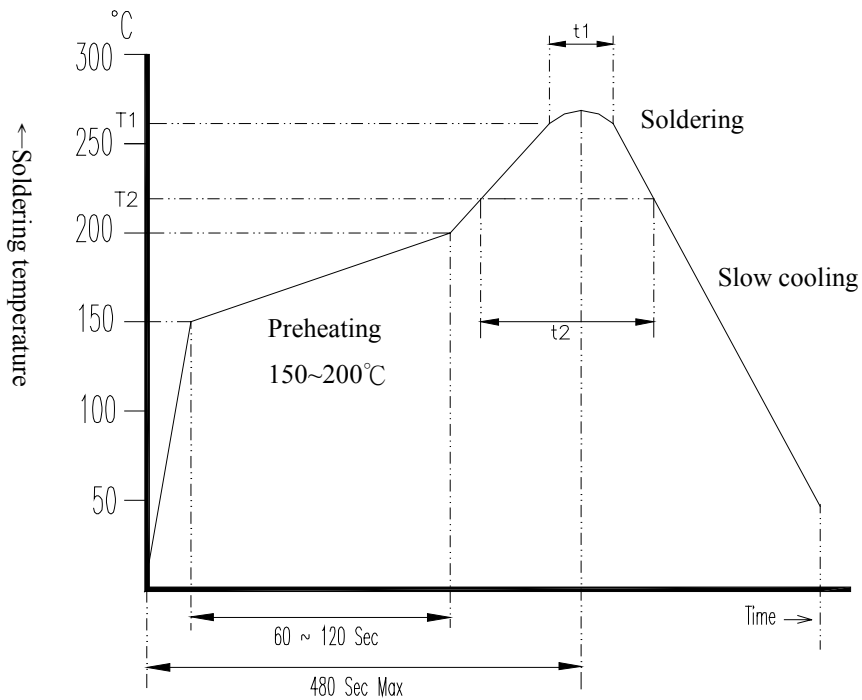

Application\Temperature Time	T1 / t1	T2 / t2
Lead Free	260±5°C / 10±5 Sec Max	217°C Min / 60~150 Sec
Non Lead Free	240±5°C / 10±5 Sec Max	183°C Min / 60~150 Sec

■ PACKING

Unit: mm

1. CARRIER TYPE

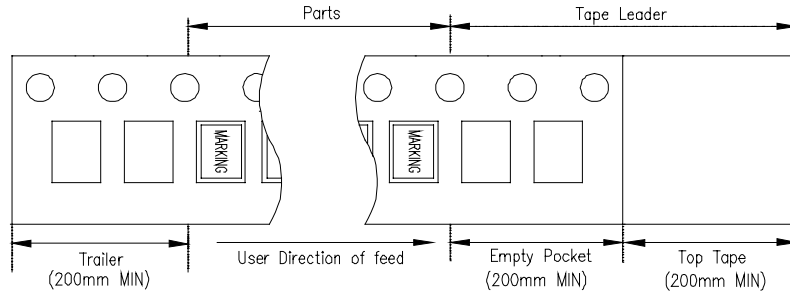
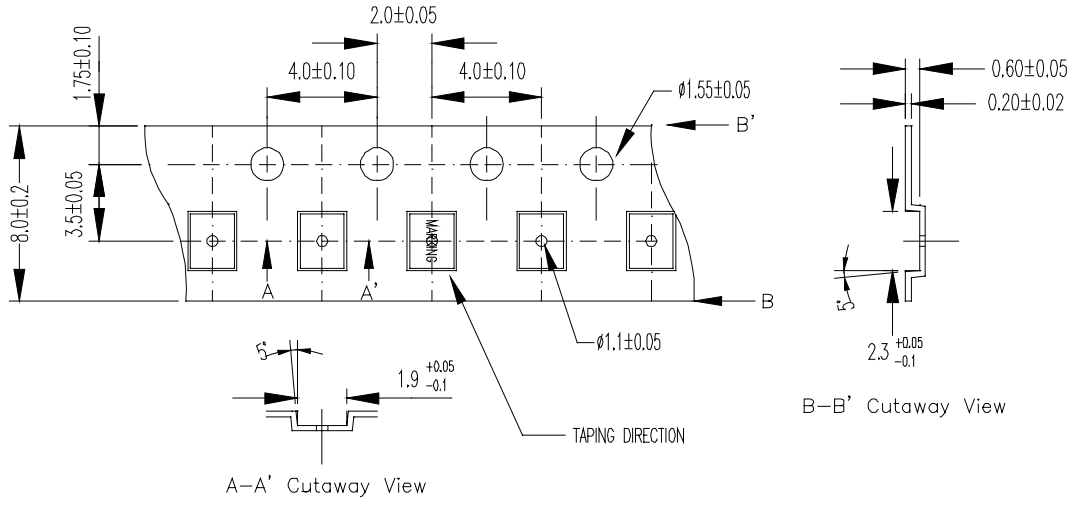

2. REEL : 3000 PCS

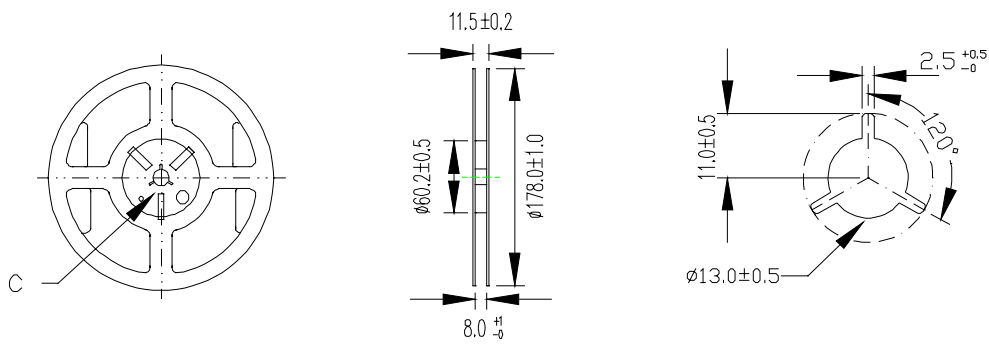

3. LABEL

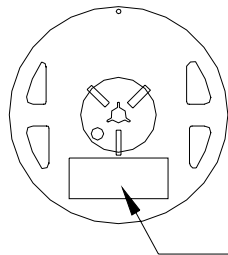

CUSTOMER:		
FREQ :		QC
TYPE :		OK
SPEC :		Pb
P.O.:		HF
CUST.P/N.:		
LOT NO.:		
MFG.P/N.:		
D.C.:	RoHS	
QTY.:		

SIWARD